

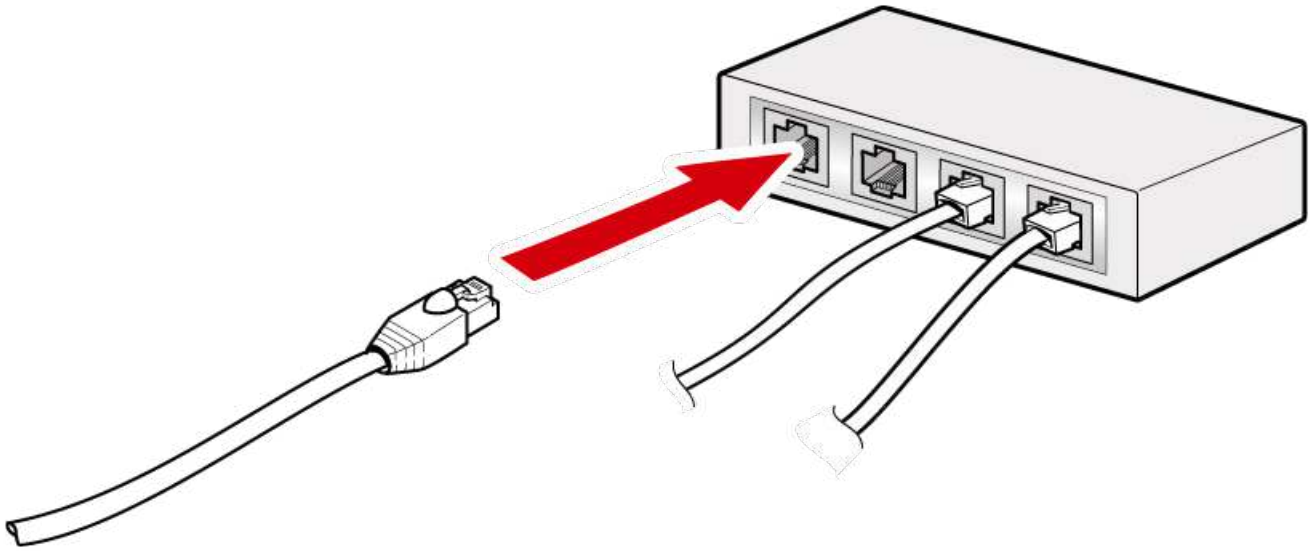

# LAN Printer Setup

This guide will help you to setup  
StarMicronics LAN printer.

1. Connect one side of the LAN cable to the hub/router:



2. Connect the other side of the LAN cable to the LAN connector of the printer:

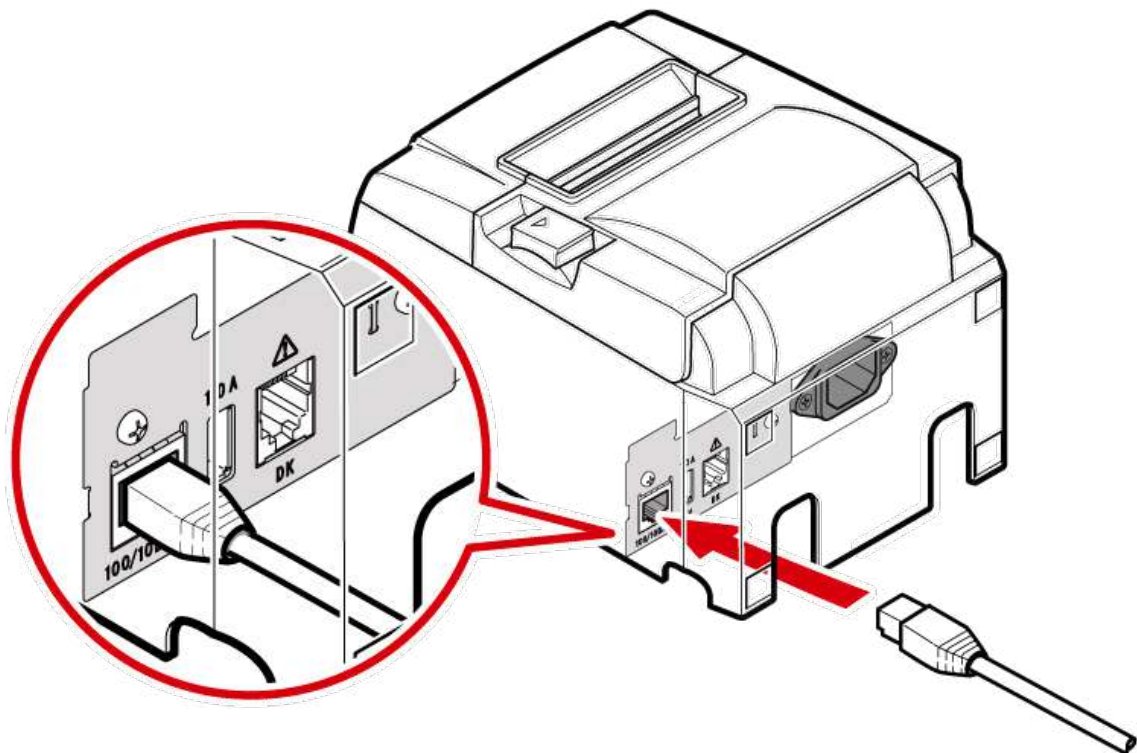

3. Wire the LAN cable. There are 4 cable outlets to the right/left/back, and it can be wired according to where the device is placed.

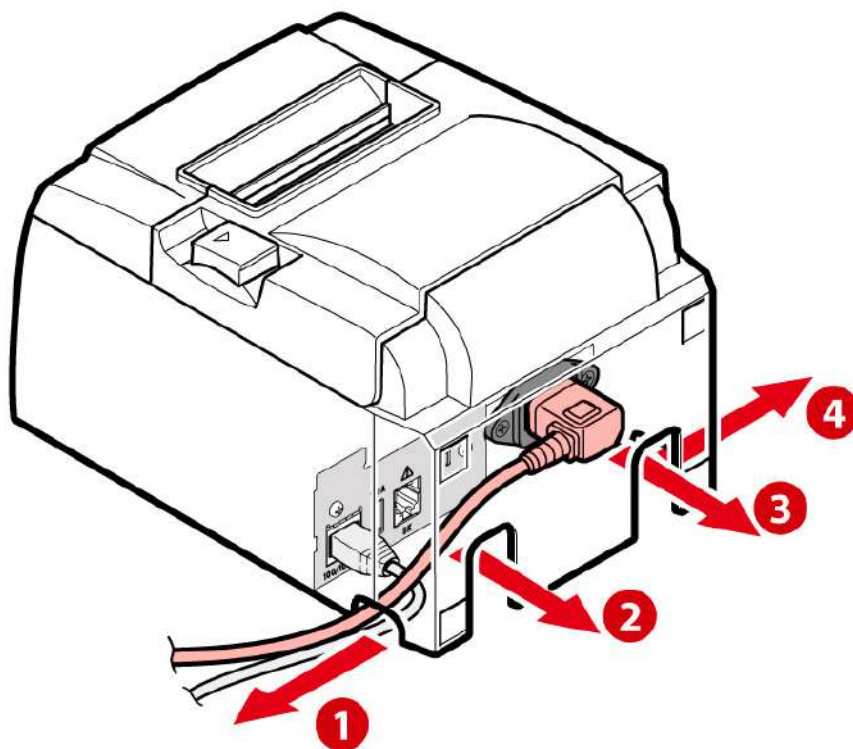

4. Connect power cable:

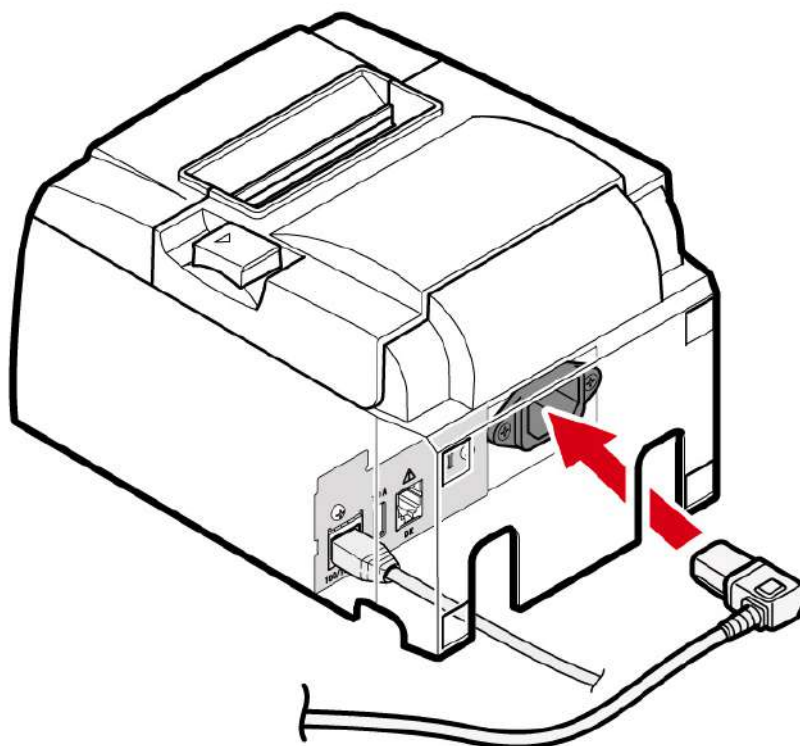

5. Wire power cable. There are 4 cable outlets to the right/left/back, and it can be wired according to where the device is placed.

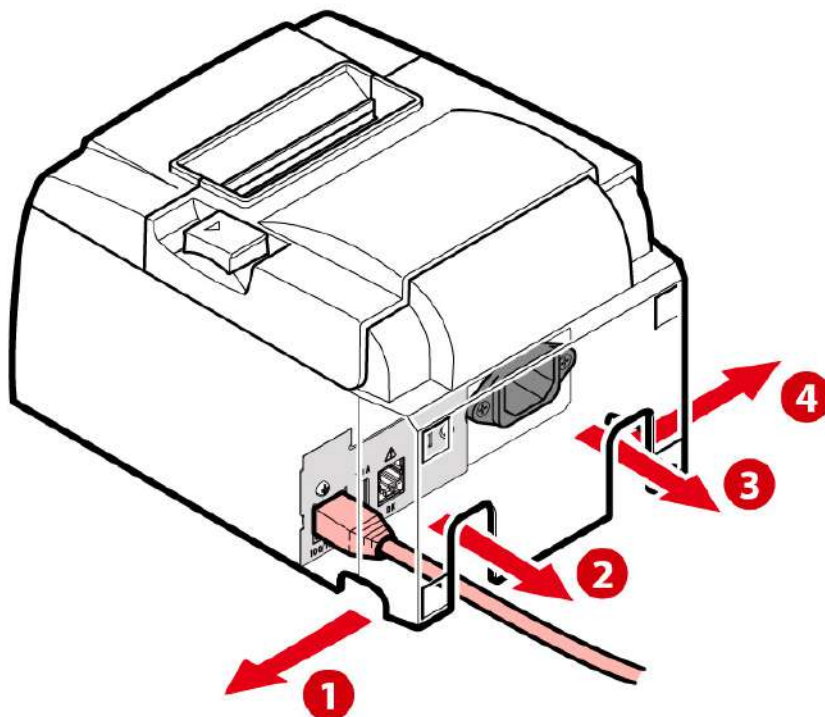

6. Insert power cable plug into electrical outlet:

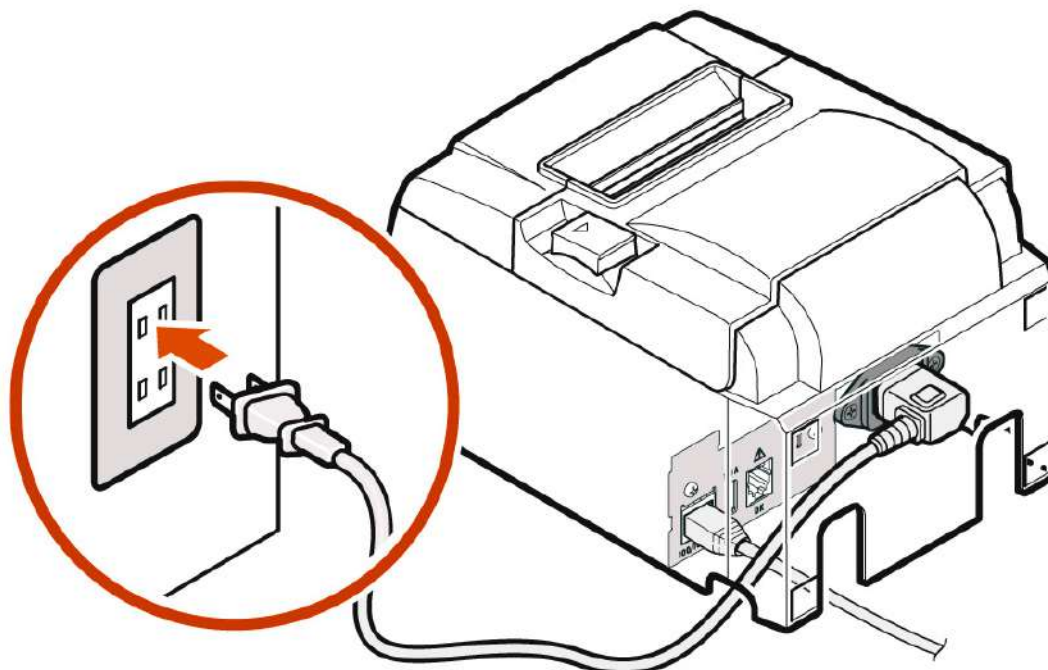

7. Turn power on. Open **vGrubs** application on your tablet:

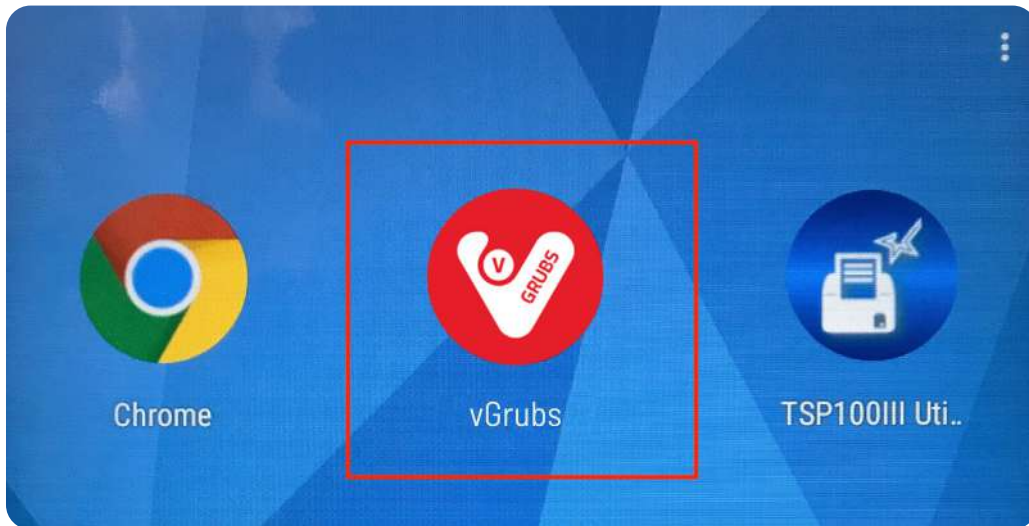

8. Open Main menu:

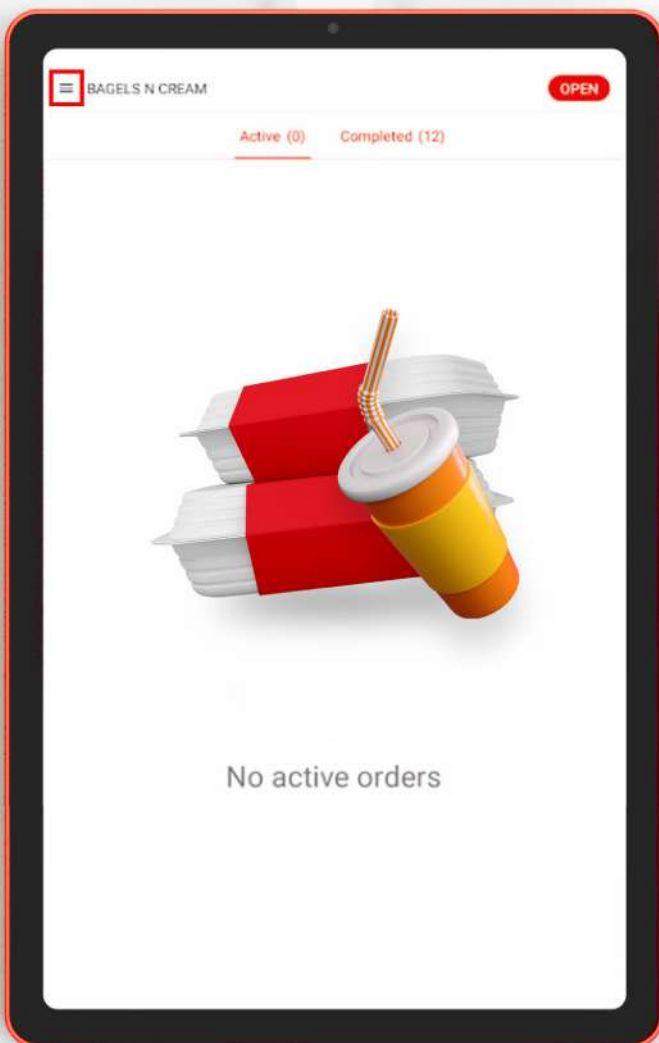

9. Navigate to Settings page:

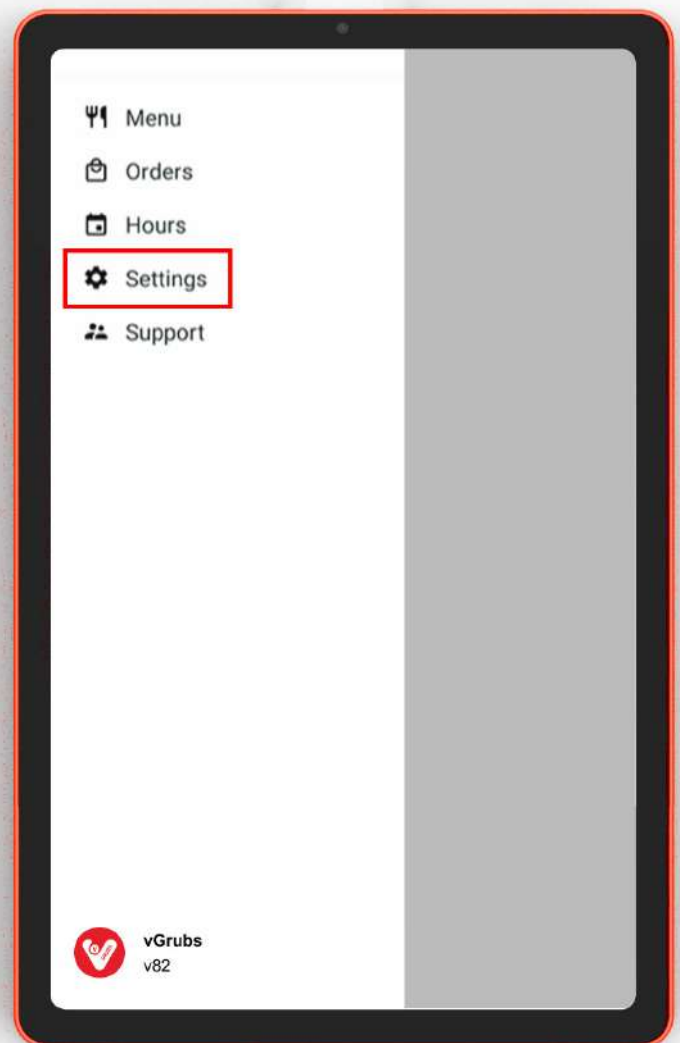

10. Press Printer setup:

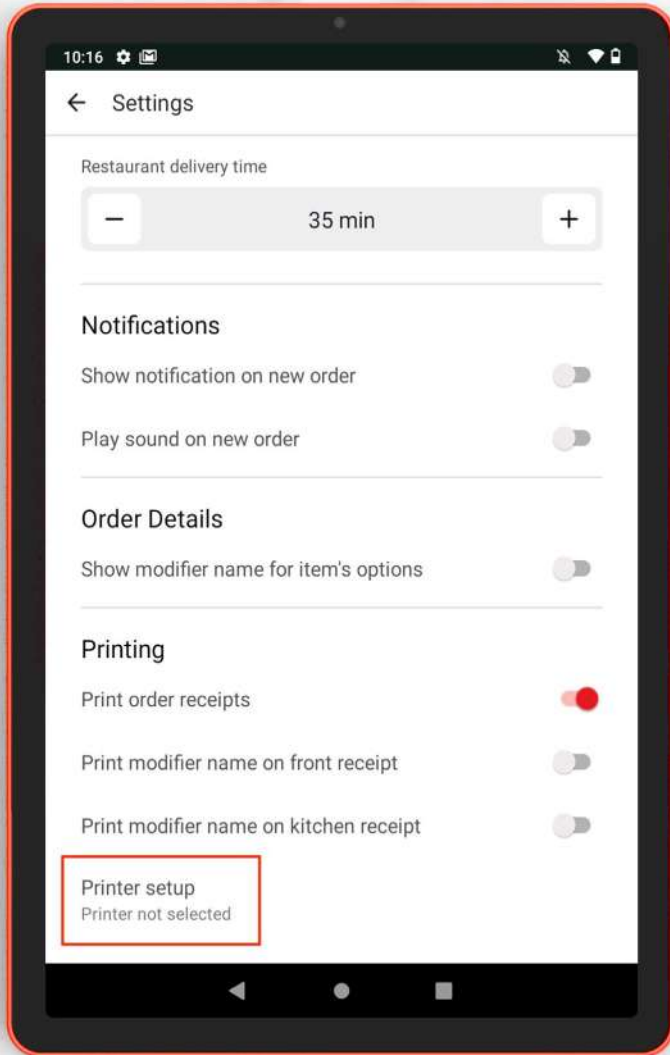

11. Wait for a while:



If printer configuration is valid, you will see your printer on next screen.  
Select it. That's all. Printer is ready to work.



99 Wall St Suite 5868, New York NY 10005

(818) 600-7488  
info@vgrubs.com  
vgrubs.com

